

# Data Sheet



Article number: 12516800330500  
Description: KLEE-coil 516 800 330.500  
M3 Stainless 1.4305

## Measures

---

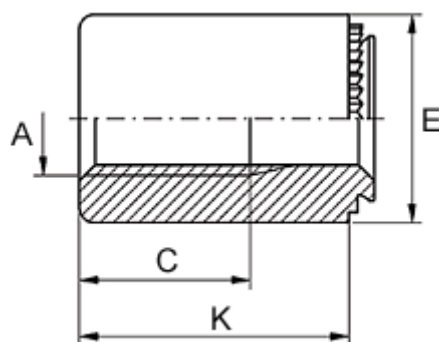

|                                 |            |
|---------------------------------|------------|
| Female thread A                 | = M3       |
| Height K                        | = 16       |
| Min distance to edge            | = 4.0      |
| Outer diameter E                | = 7        |
| Plate thickness                 | = from 2.4 |
| Recommended bore diameter +0.05 | = 5.00     |
| Thread length                   | = 8.0      |